

## 1- Overview

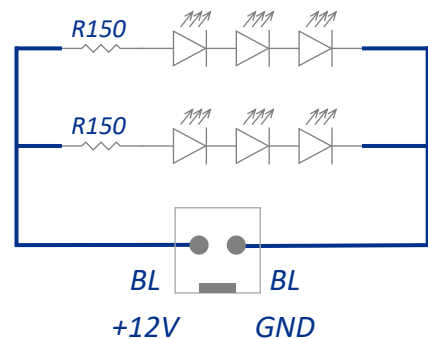

## 2- Kit content

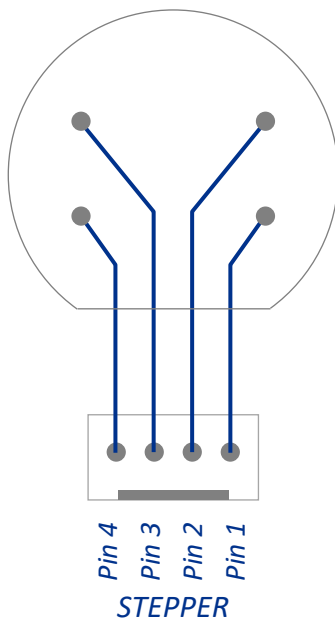
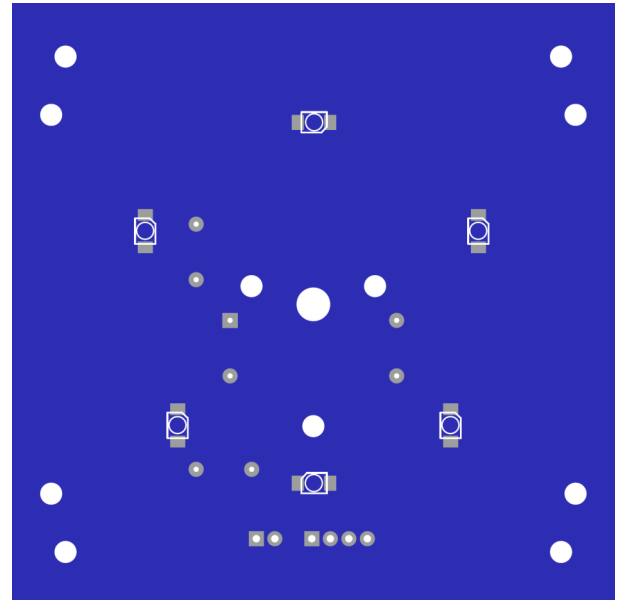
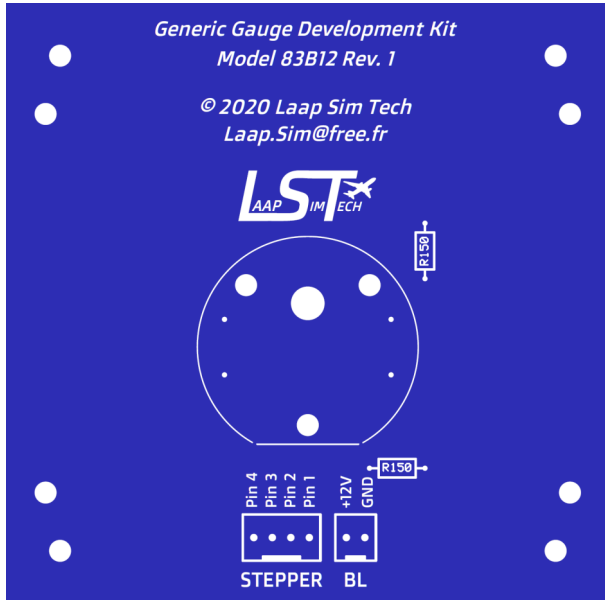
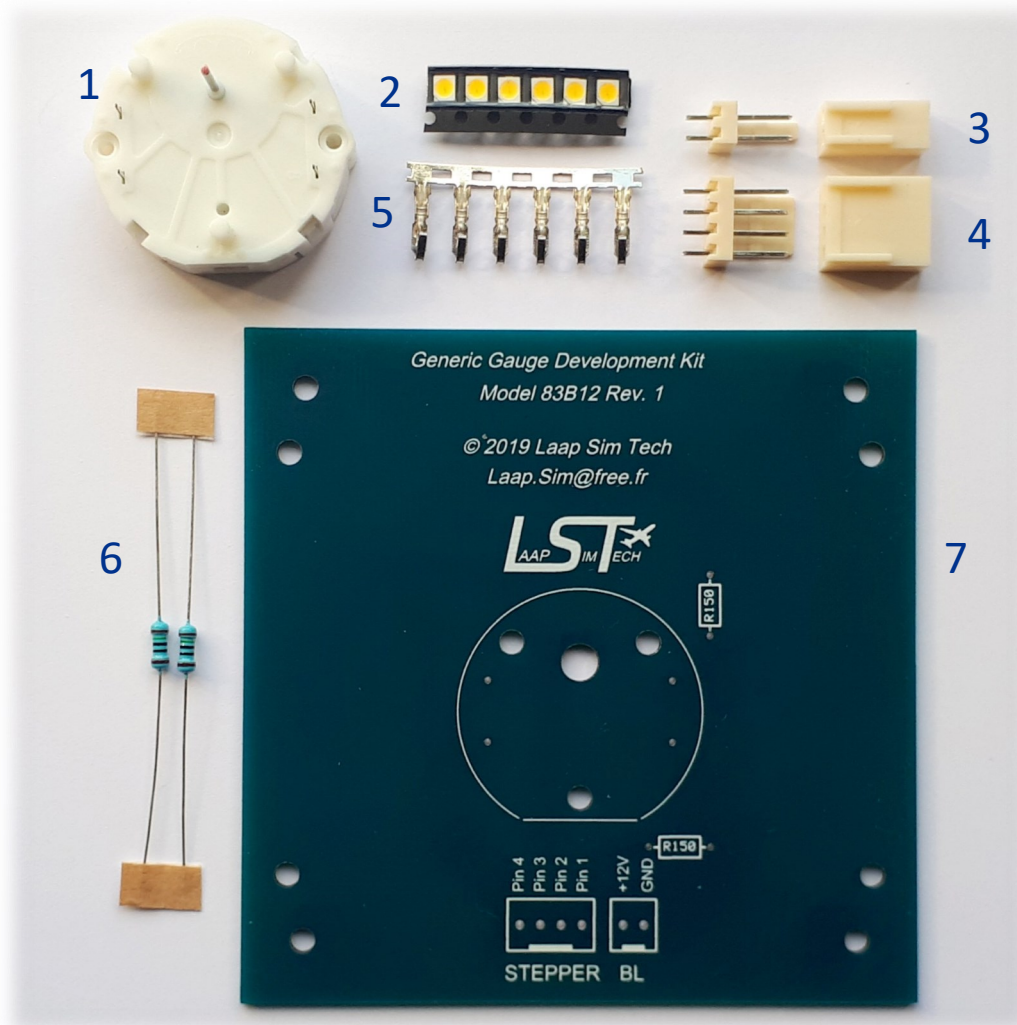

(1)	X27 Stepper	x1
(2)	SMD Leds	x6
(3)	2 pin connector (M + F)	x1
(4)	4 pin connector (M + F)	x1
(5)	Contacts for female connectors	x6
(6)	150 $\Omega$ resistors	x2
(7)	PCB model 83B12	x1

*3a- SMD Leds (x6)*

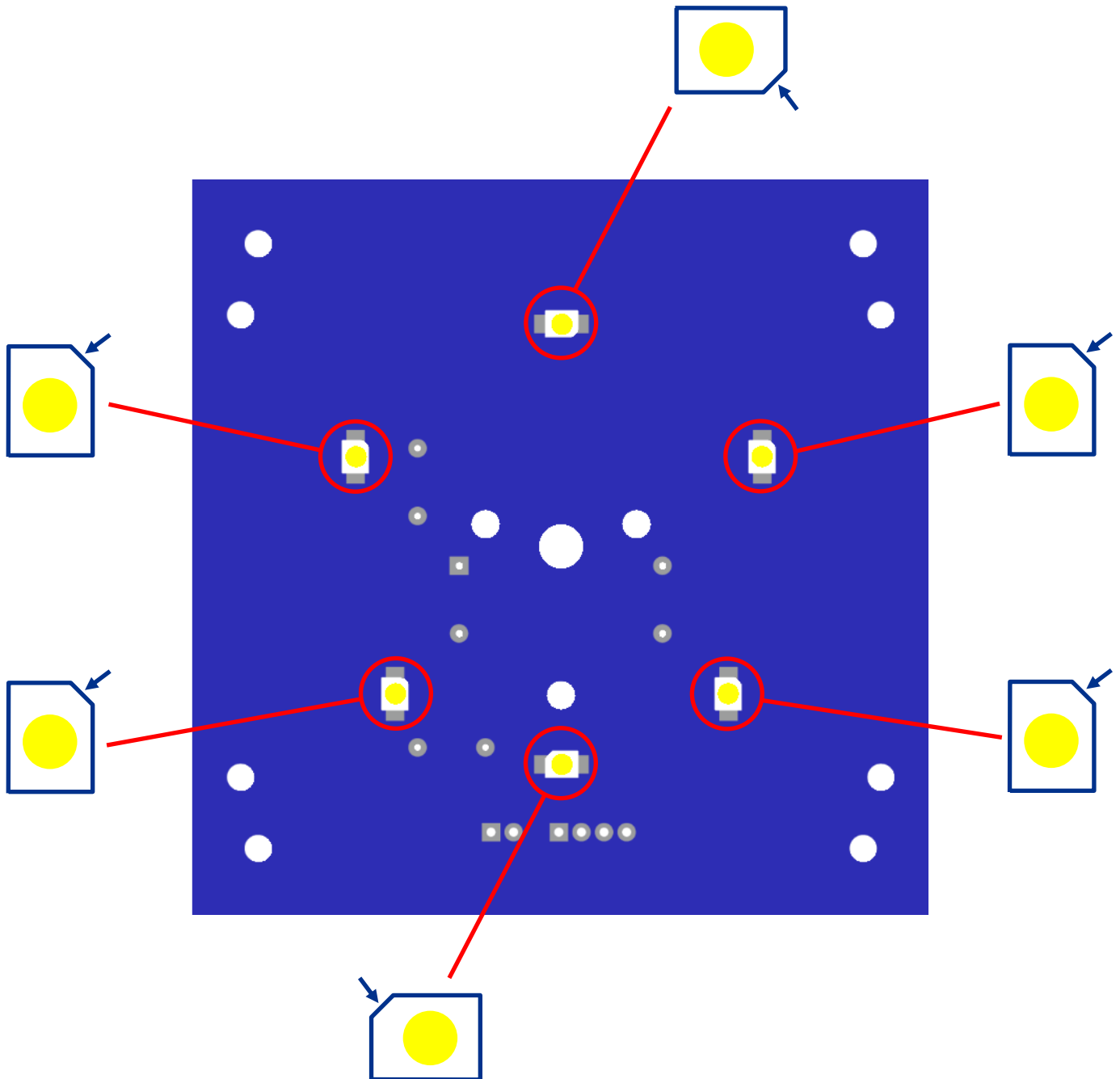

3b- Resistors R150 (x2)

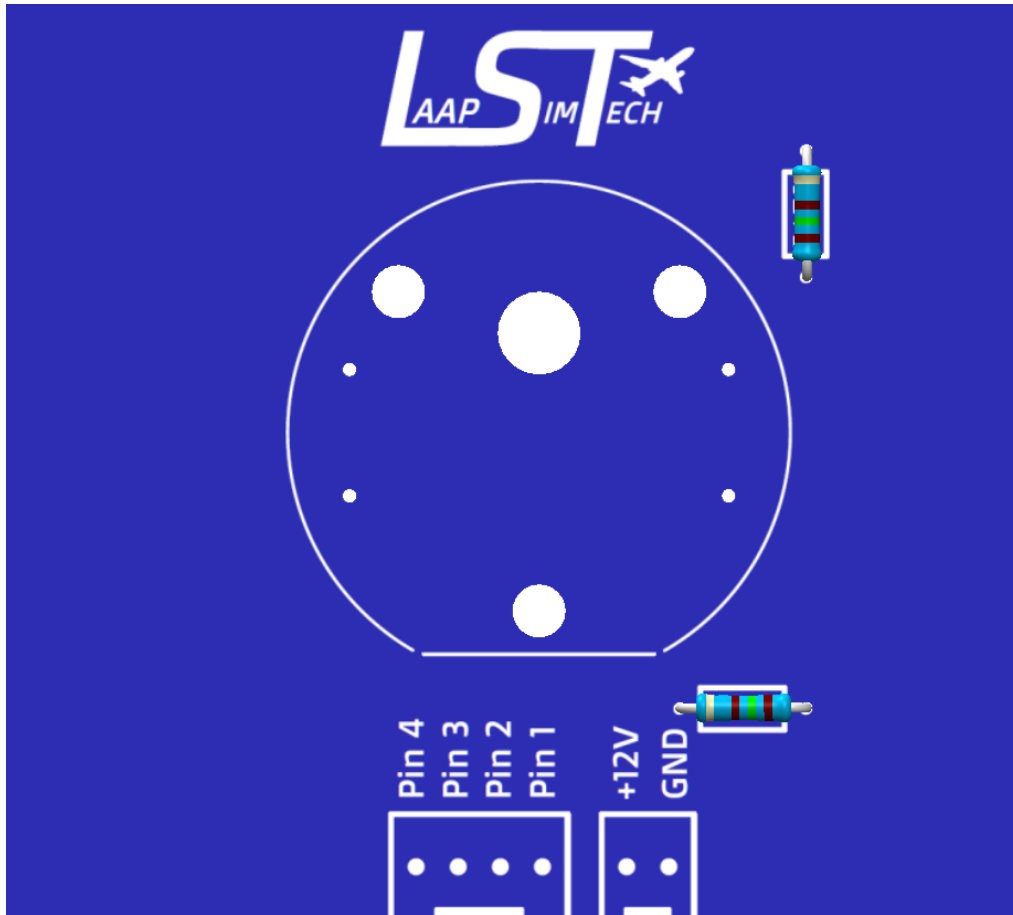

### 3c- Stepper motor



### 3d- Connectors (x2)

