

1- Overview

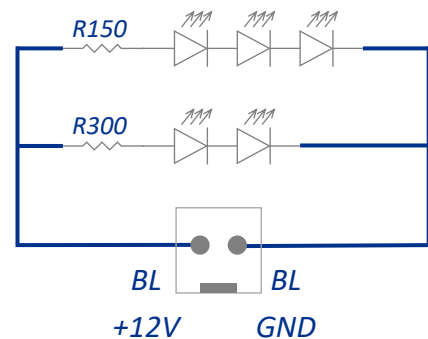

2- Kit content

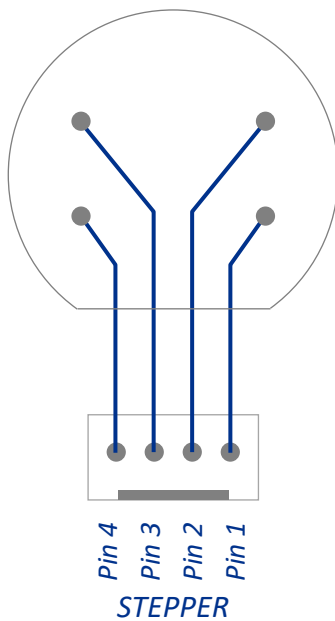
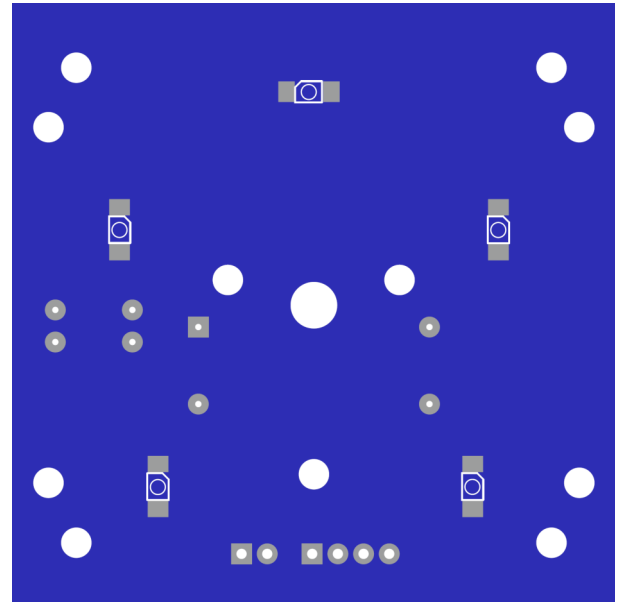
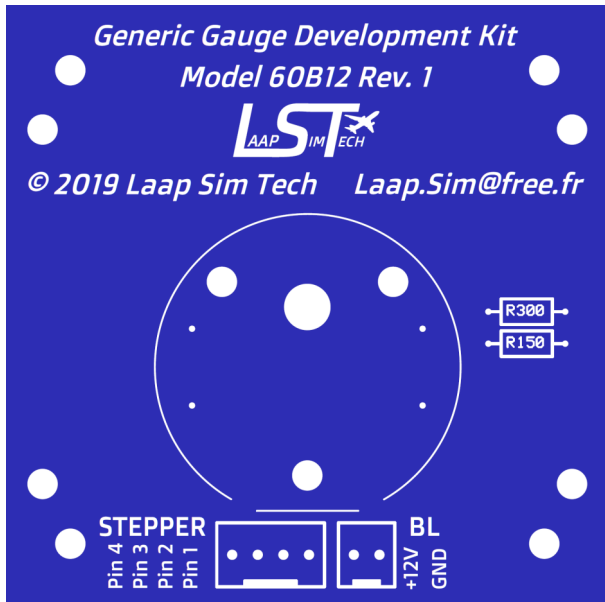
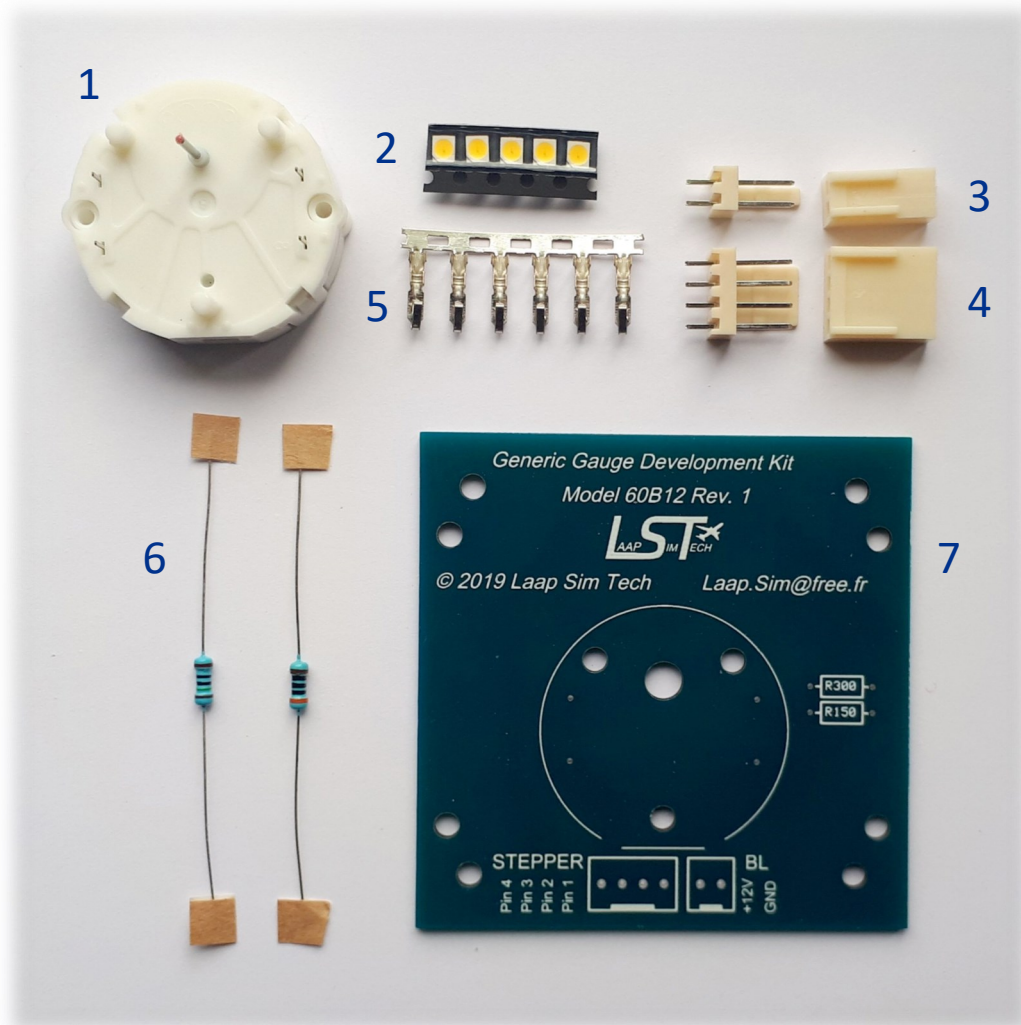

(1)	X27 Stepper	x1
(2)	SMD Leds	x5
(3)	2 pin connector (M + F)	x1
(4)	4 pin connector (M + F)	x1
(5)	Contacts for female connectors	x6
(6)	150Ω + 300Ω resistors	x2
(7)	PCB model 60B12	x1

3a- SMD Leds (x5)

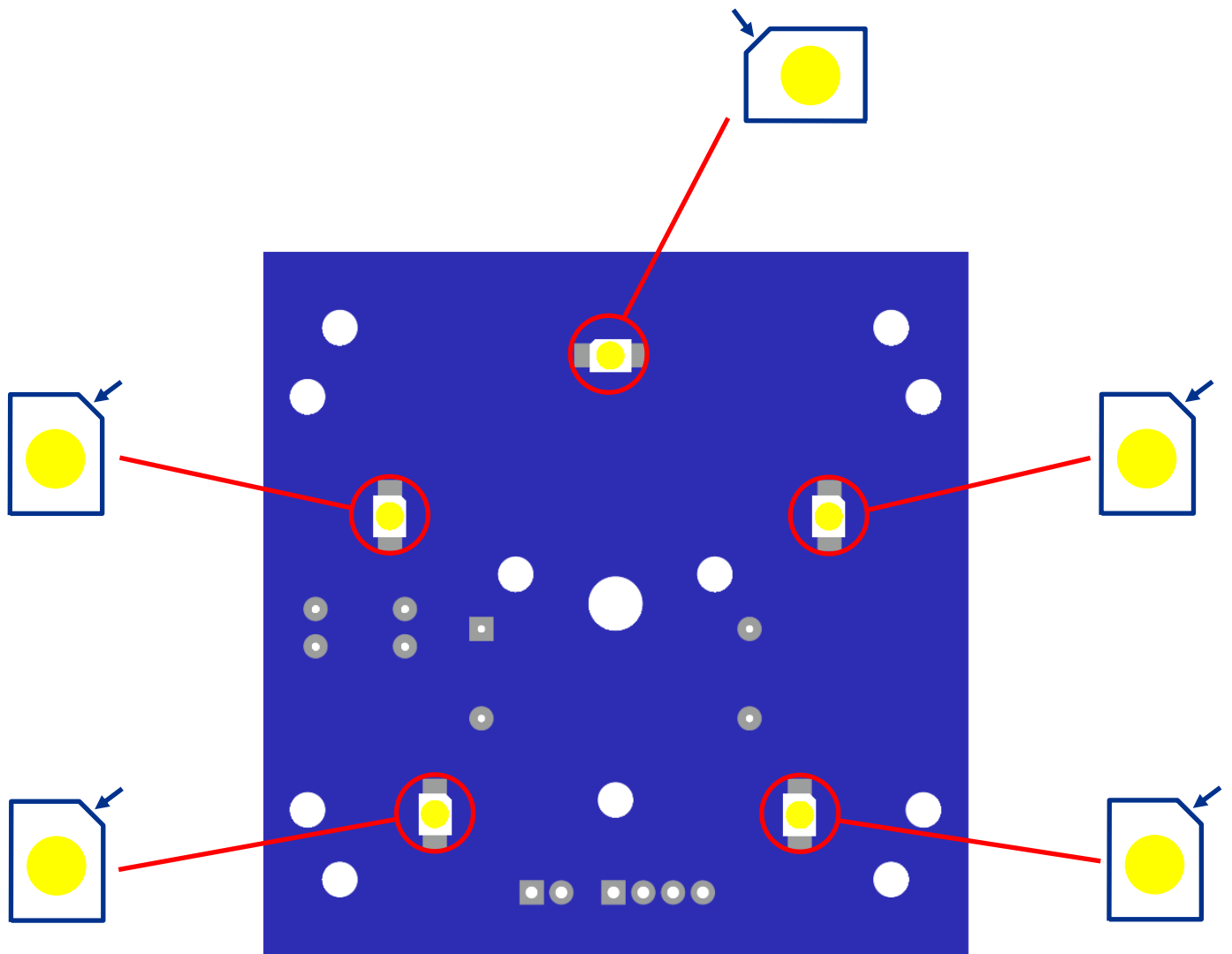

3b- Resistors R150 / R300

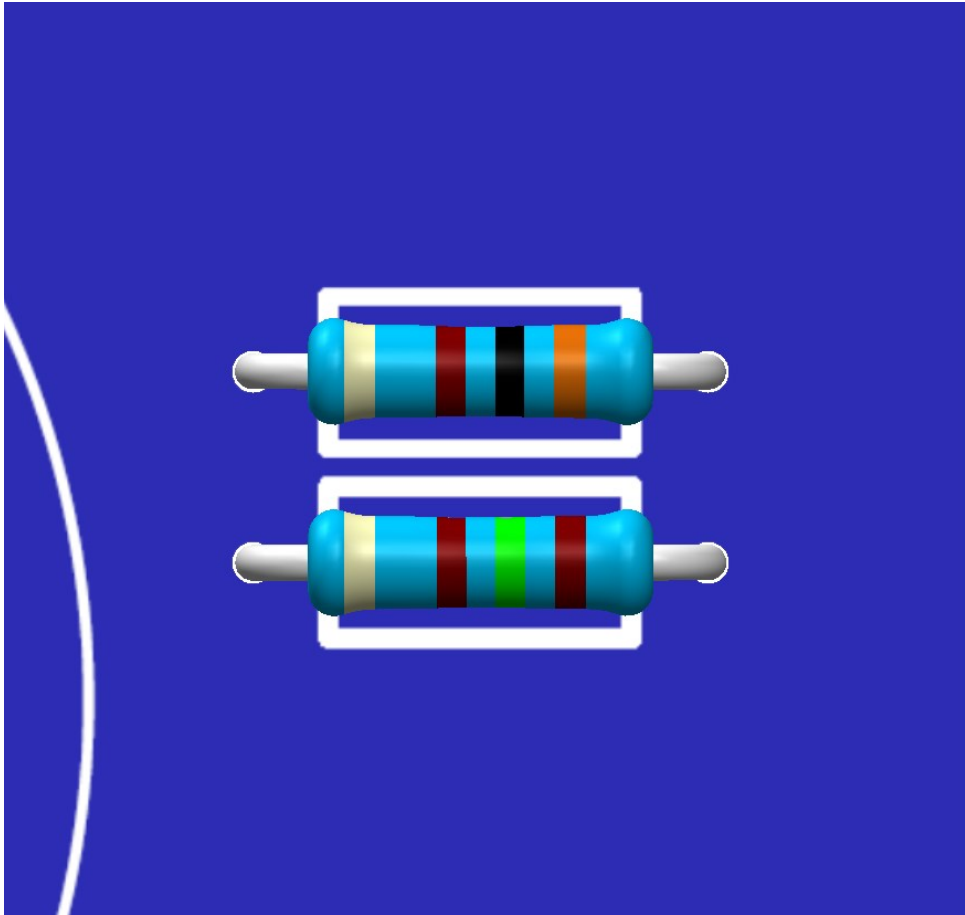

3c- Stepper motor

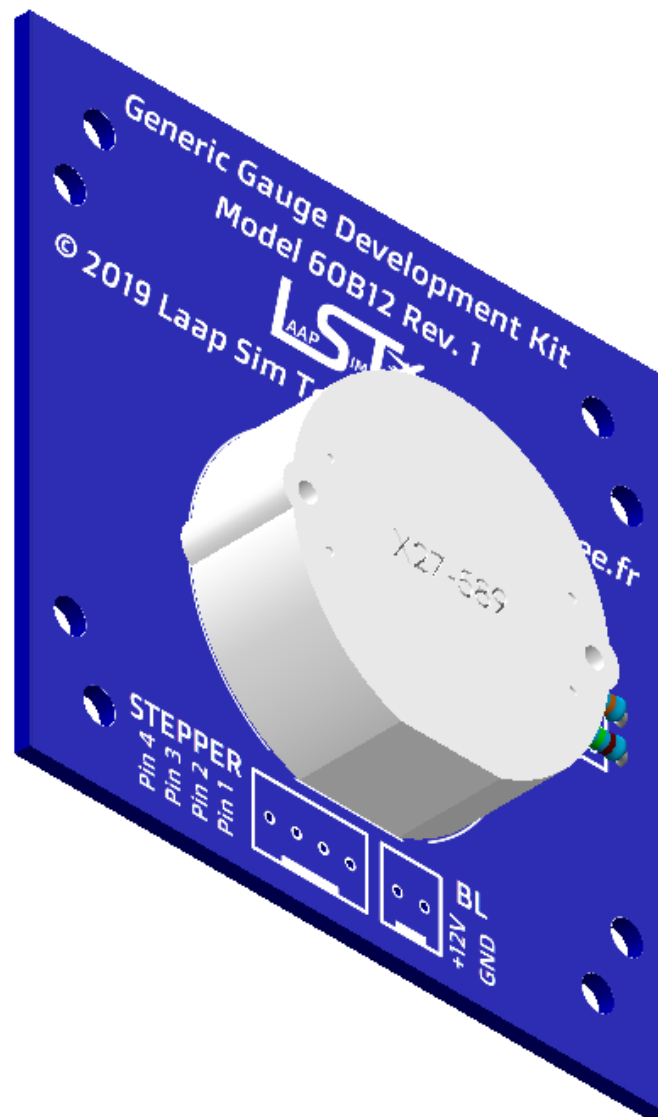

3d- Connectors (x2)

